

# KIPOR<sup>®</sup>

## KIPOR POWER

### OPERATION MANUAL

PLEASE READ THIS MANUAL CAREFULLY.  
IT CONTAINS IMPORTANT SAFETY INFORMATION.

[WWW.KIPOR.COM](http://WWW.KIPOR.COM)

# KIPOR<sup>®</sup>

**WUXI KIPOR POWER CO., LTD.**

Address: Beside Jingyi Rd, Third-stage Development Section of  
Wangzhuang Industry Area, Wuxi High  
& New Technology Industry Development Zone.

TEL: 0086-510-85205041

FAX: 0086-510-85203796

E-MAIL: kipor@kipor.com



## OPEN-FRAME GASOLINE GENERATOR

**SINGLE-PHASE: KGE2500X/E**

**KGE4000X**

**KGE6500X/E**

**THREE-PHASE: KGE6500X3/E3**



# CONTENTS

1. Safety information .....	1
2. Identification of components .....	2
3. Pre-operation check .....	3
4. Starting the generating set .....	5
5. Usage of the generating set .....	6
6. Stopping the generating set .....	9
7. Maintenance .....	10
8. Storage .....	14
9. Troubleshooting .....	15
10. Main technical specifications and data .....	16
11. Description of accumulator unit .....	19
12. Description of castor unit .....	20
13. Wiring diagram .....	21
14. Appendix .....	27

**EC Declaration of Conformity**  
**According to EU Machinery-Directive 98/37/EC**

**We, Wuxi Kipor Power Co., Ltd.** ( Add: Beside Jingyi Rd, Third-stage Development Section of Wangzhuang Industry Area, Wuxi High & New Technology Industry Development Zone.)

declare under our sole responsibility that the product gasoline generator set: KGE2500X, KGE2500E, KGE4000X, KGE6500X, KGE6500E, KGE6500X3, KGE6500E3, to which this declaration relates correspond to the relevant basic safety and health requirements of Directive:

- 98/37/EC (Machinery-Directive),
- 2006/95/EC(LVD-Directive),
- 89/336/EC (EMC-Directive), and
- 2000/14/EC (noise directive) incl. modifications.

For the relevant implementation of the safety and health requirements mentioned in the Directives, the following standards and/or technical specification(s) have been respected:

EN 55012:2002/+A1:2005,  
 EN 12601: 2001,  
 EN ISO 3744, ISO 11094.

Mode Item	KGE2500X KGE2500E	KGE4000X	KGE6500X	KGE6500E	KGE6500X3	KGE6500E3
Measured sound power level	92.57dB(A)	94.0dB(A)	94.0dB(A)	94.0dB(A)	94.0dB(A)	94.0dB(A)
Guaranteed sound power level	93.0dB(A)	95.0dB(A)	95.0dB(A)	95.0dB(A)	95.0dB(A)	95.0dB(A)

Conformity assessment method to annex VI/Directive 2000/14/EC

Maintenance of technical documentation:

**Wuxi Kipor Power Co., Ltd.**

Signature: Shuoming Huang

Name: Shuoming Huang

Quality Guarentee Manager

## 2. Modified coefficient table of ambient condition power

The conditions of generator rated output:

Altitude: 0 m      Ambient temperature: 25°C      Relative humidity: 30%

Ambient modified coefficient: C (Relative humidity 30%)

Altitude (m)	Ambient temperature (°C)				
	25	30	35	40	45
0	1	0.98	0.96	0.93	0.90
500	0.93	0.91	0.89	0.87	0.84
1000	0.87	0.85	0.82	0.80	0.78
2000	0.75	0.73	0.71	0.69	0.66
3000	0.64	0.62	0.6	0.58	0.56
4000	0.54	0.52	0.5	0.48	0.46

Note: When the relative humidity is 60%, the modified coefficient is C-0.01

When the relative humidity is 80%, the modified coefficient is C-0.02

When the relative humidity is 90%, the modified coefficient is C-0.03

When the relative humidity is 100%, the modified coefficient is C-0.04

Counting example:

When the rated power of generator is  $P_N = 5\text{KW}$ , altitude is 1000m, ambient temperature is 35°C, relative humidity is 80%, the rated power of generator is:

$$P = P_N \times (C - 0.02) = 5 \times (0.82 - 0.02) = 4\text{KW}$$

## 1. SAFETY INFORMATION

In order to operate this generating set safely and reliably, please follow the below requirements.

1-1 Do not operate it at well ventilated place, for the exhaust contains poisonous carbon monoxide. Do not operate it at unventilated place! (see fig.1)

1-2 Do not operate it under wet condition.(see fig.2)

1-3 Don't connect the generator to other power supplies. Such as main-supply of power company. In some special cases, please connect the stand-by power to the electrical system by professional electrician who must know the difference between public supply and generator circuit. And who should realize the difference between the utility supply network and generator circuit.(See fig.3)

1-4 The set must be kept away from the flammable materials at least one meter. (see fig.4)

1-5 Smoking and igniting and sparking are not allowed while refilling. (see fig.5)

1-6 Stop the generating set while refilling. (see fig.6)

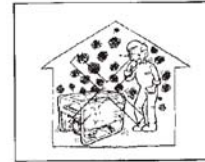

Fig.1



Fig.2

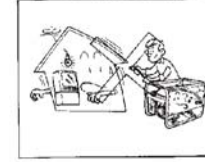

Fig.3

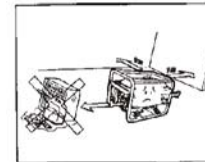

Fig.4



Fig.5



Fig.6

1-7 Do not overflow the fuel oil while refilling. Otherwise, wipe off the overflowed fuel oil if happened. (see fig.7)

1-8 Keep the set in level position while running.

1-9 Laymen especially the children can not realize the danger, they should keep away from the generator.

1-10 Do not touch the muffler or any over-hot parts to prevent injuring when the set is running or just stopped.

1-11 Please wear suitable clothes and safety protective coverall.

1-12 For security, the door lock key of E/E3 should be well kept by operator. Please lock the doors of generator tightly to prevent layman to operate (the children can not realize the danger)

1-13 The installation and maintenance work should be operated by professional maintainer.

1-14 It is limited to use the generator in the high-hazard risk area.

1-15 Don't pour waste oil into the sewer or the river to prevent environment pollution. The exhaust oil from generator must be stored in container. To deal with bad matter, such as fuel, oil cooling water, solvent, filter and battery, according to the law.

1-16 Be careful when operate the generator, because the fuel and exhaust is poisonous.



Fig.7

## 2. IDENTIFICATION OF COMPONENTS

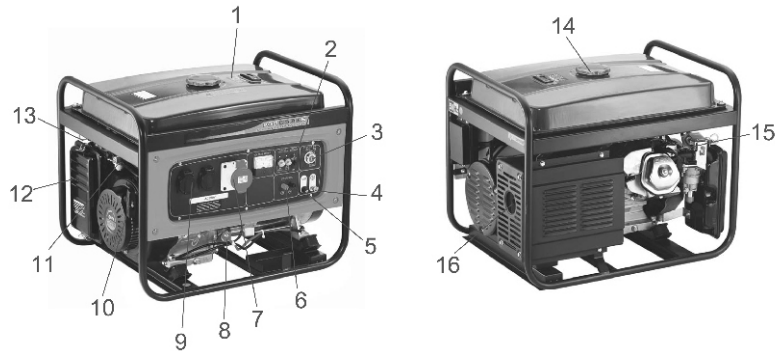

- |                      |                       |
|----------------------|-----------------------|
| (1). Fuel tank       | (9). AC receptacle    |
| (2). AC breaker      | (10). Starter grip    |
| (3). Starter switch  | (11). Fuel switch     |
| (4). Ground terminal | (12). Air cleaner     |
| (5). Fuse seat       | (13). Choke wrench    |
| (6). DC post head    | (14). Fuel filler cap |
| (7). AC receptacle   | (15). Spark plug      |
| (8). Oil filler cap  | (16). Exhaust muffler |

## 14. APPENDIX

### 1. The choice of the electric cable

The choice of the electric cable depends on the allowable current of the cable and the distance between the load and the generator. And the cable section should be big enough.

If the current in the cable is bigger than the allowable current, it will become over hot and the cable will be burnt. If the cable is long and thin, the input voltage of the electric appliance will be not enough, causing that the generator doesn't start. In the following formula, you can calculate the value of the potential "e".

$$\text{Potential (v)} = \frac{1}{58} \times \frac{\text{Length}}{\text{Section area}} \times \text{Current (A)} \times \sqrt{3}$$

The relations among of the allowable current, and length, section of the Insulating cable (single core, multi-core) are as follow:

(Presume that the use voltage is 220V and the potential is below 10V.

#### The application of the single-core insulating cable section mm<sup>2</sup>

Length beneath Current	50m	75m	100m	125	150	200
50A	8	14	22	22	30	38
100A	22	30	38	50	50	60
200A	60	60	60	80	100	125
300A	100	100	100	125	150	200

#### The application of the multi-core insulating cable section mm<sup>2</sup>

Length beneath Current	50m	75m	100m	125	150	200
50A	14	14	22	22	30	38
100A	38	38	38	50	50	60
200A	38×2	38×2	38×2	50×2	50×2	50×2
300A	60×2	60×2	60×2	60×2	80×2	100×2

### 13-6 Electric skeleton diagram of KGE6500E3

ON-OFF Table of Electric Starter Key

	①	②	③	④	⑤	⑥	⑦
OFF				○—○		○—○	
ON	○—○						
START	○—○	○—○					

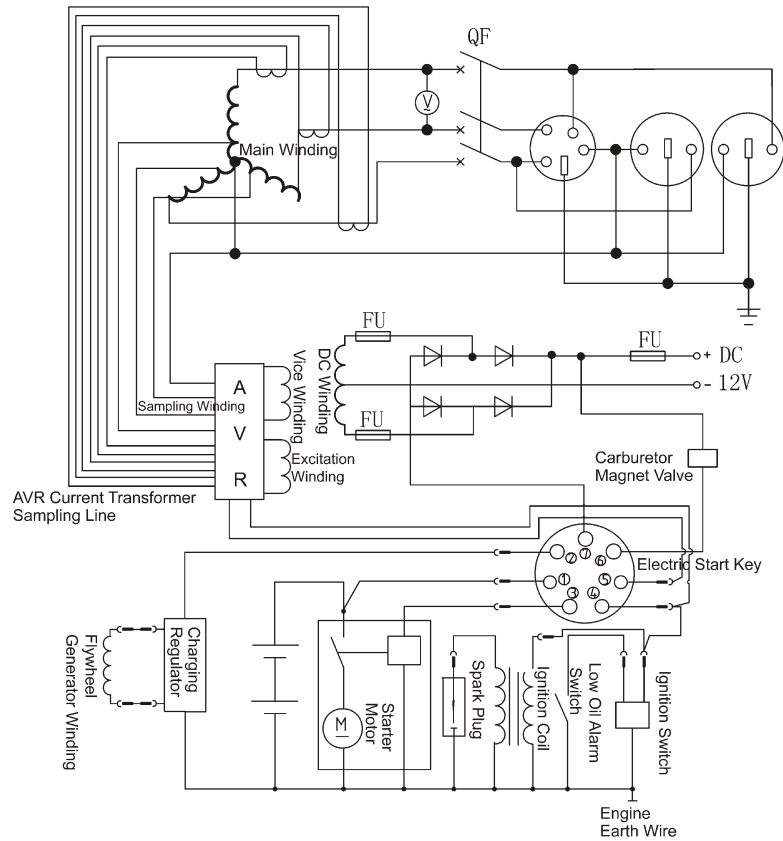

## 3. PRE-OPERATION CHECKS

Be sure to perform the following checks before starting the generating set.

### 3-1 Check whether the generating set is on a level surface.

### 3-2 Check the level of engine oil

- (1) Take out the oil filler cap and clean the measure mark with a clean rag. (see fig.8)
- (2) Insert the oil filler cap without rotating it.
- (3) If the oil level is below the lower level, refill the oil till the upper level.
- (4) Tighten the oil filler cap.

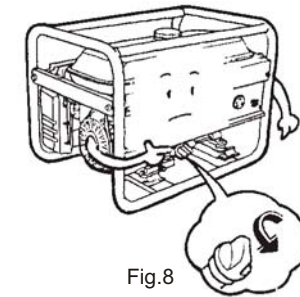
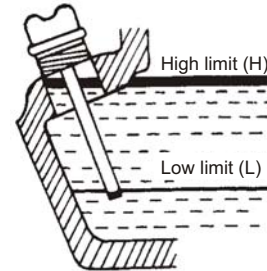

Fig.8

### 3-3 Check fuel level

- (1) Open the fuel tank.(see fig.9)
- (2) Check fuel level, refuel if the level is too low.
- (3) Refuel till the shoulder of the fuel filter.
- (4) Tighten the fuel tank cap.

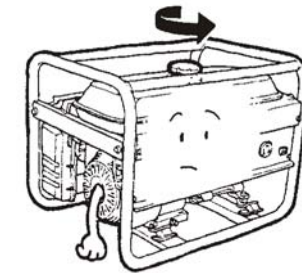
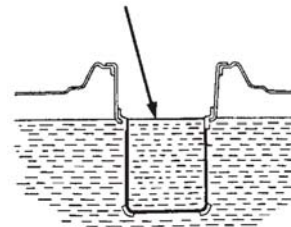
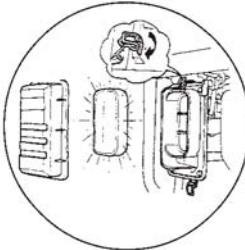
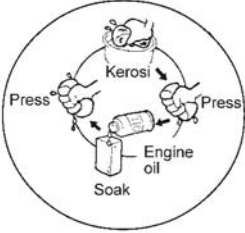
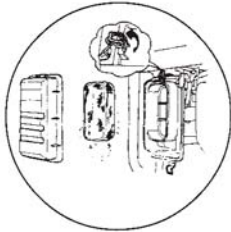

Fig.9

**3-4 Check the air cleaner**

(1) Remove the clip and dismount the case of air cleaner. Loose the nut and remove the cover of air cleaner.



(2) Clean the air cleaner.

(3) Refix the air cleaner.

**13-5 Electric skeleton diagram of KGE6500X3**

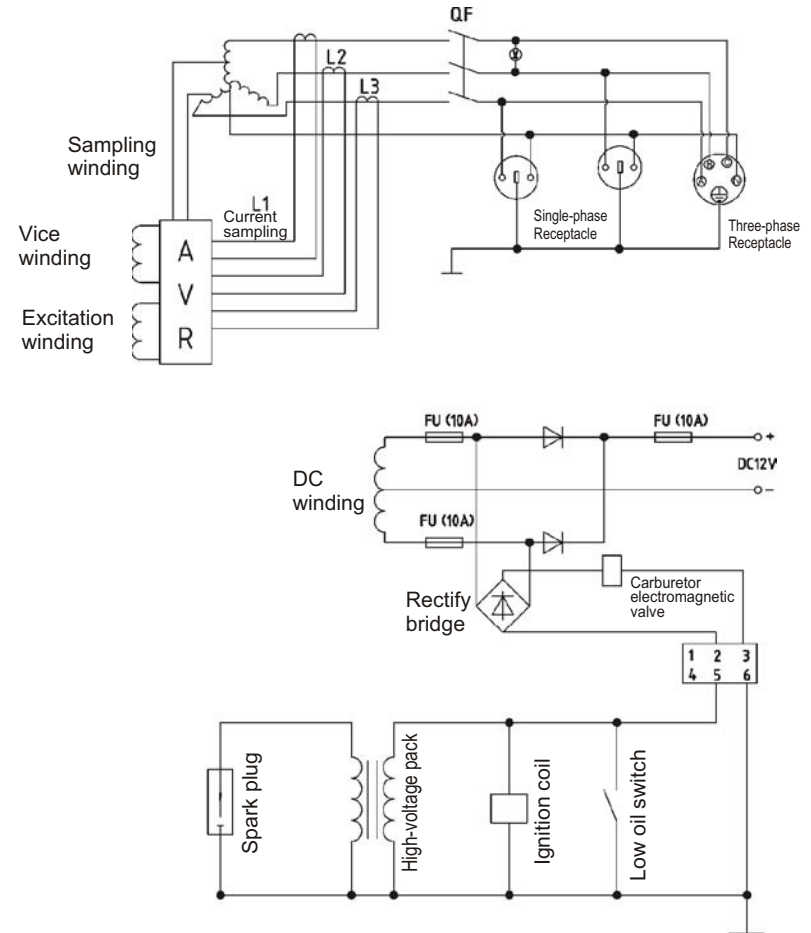



13-4 Wiring skeleton diagram of KGE6500E

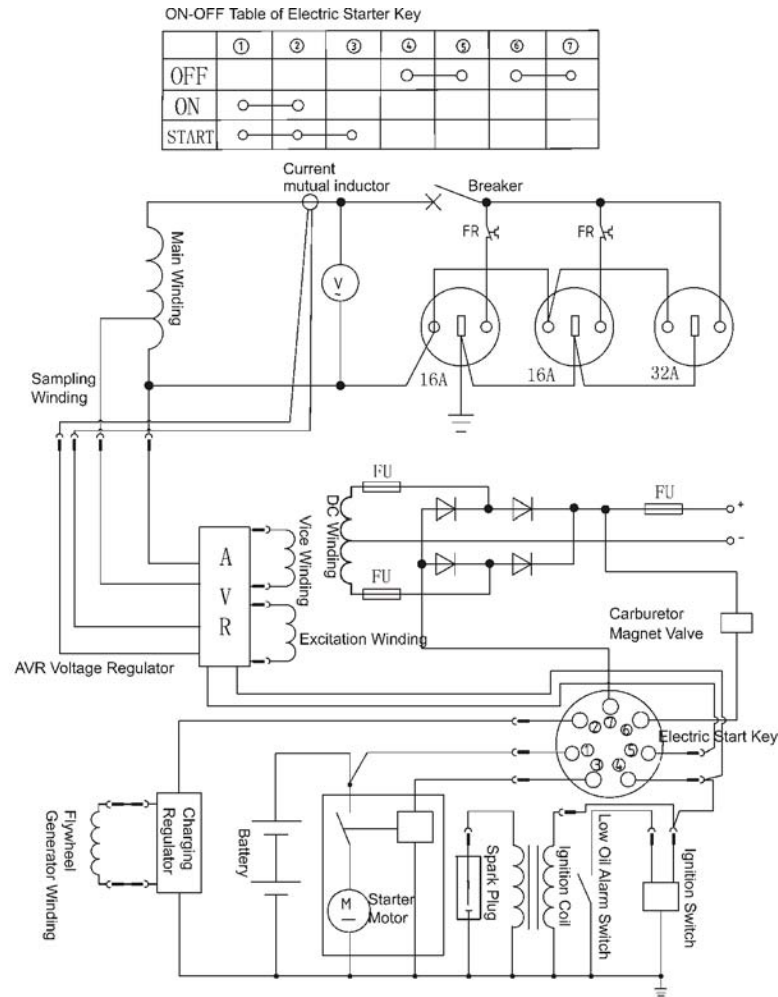

4. STARTING THE GENERATING SET

(1) Disconnect any load from AC receptacle and switch off AC breaker.

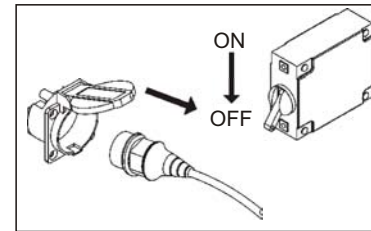

(2) Set the fuel oil valve to "ON" position.

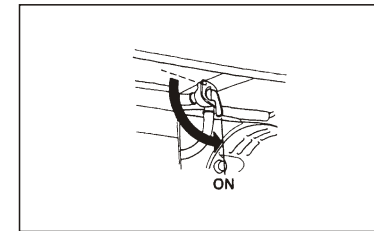

(3) Set the choke lever to "CHOKE" position.

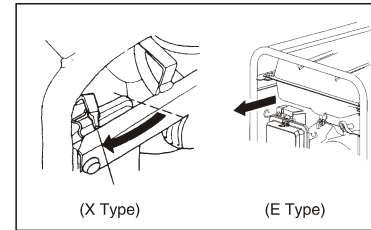

(4) Turn the engine switch to "ON" position.

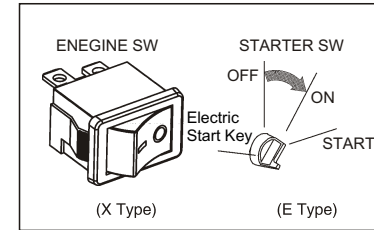

(5) Pull the starter handle slowly until you feel the resistance, then pull it by force.

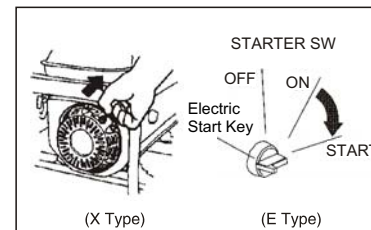

(6) When the engine is warm, set the choke lever to "OFF" position.

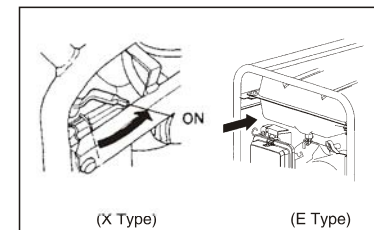

## 5. USAGE OF THE GENERATING SET

**5-1 In order to keep the generating set in best mechanical and electrical condition, please follow the blow items.**

(1) Please ground the grounding terminal of the set to prevent any false operating. Regarding C type set, grounding can be performed from the grounding tap hole which on the front(back) cover of the engine.

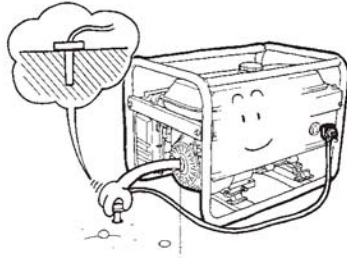

(2) Check whether AC output voltage and frequency meet the technical specifications.

(3) If the generating set will be connected with more than two loads, please connect them from that required higher starting current.

(4) Concerning connecting the set to the household circuit, which must be performed by the professional. Check whether the connection is right after the load is connected to prevent the generating set from damage or fire.

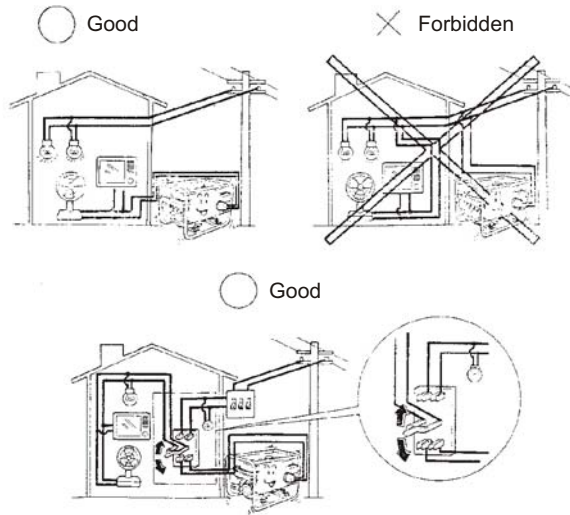

## 13-3 Electric skeleton diagram of KGE6500X

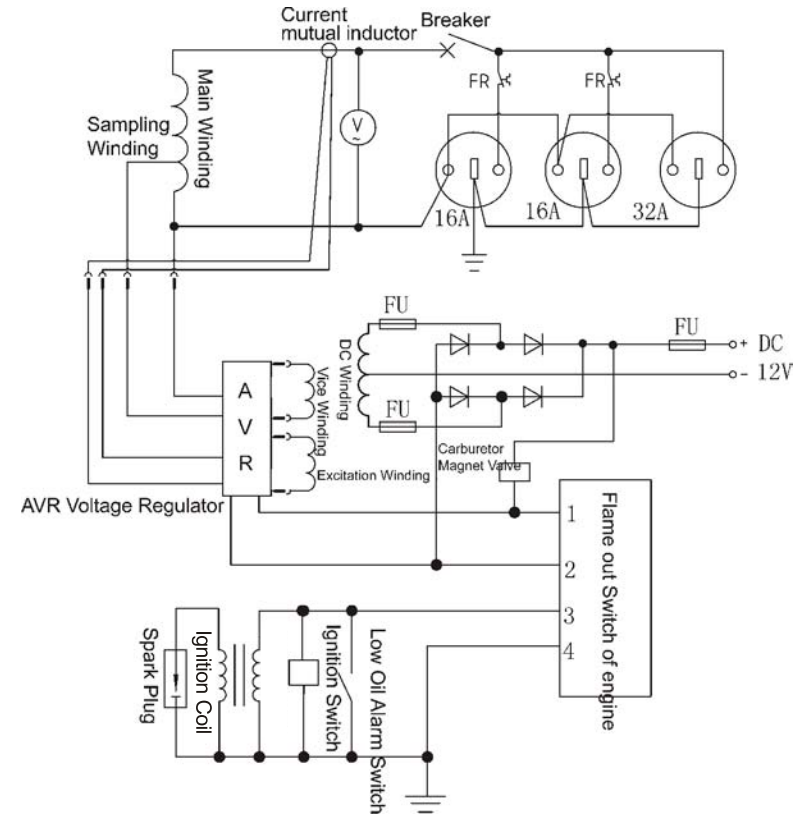

13-2 Electric skeleton diagram of KGE4000X

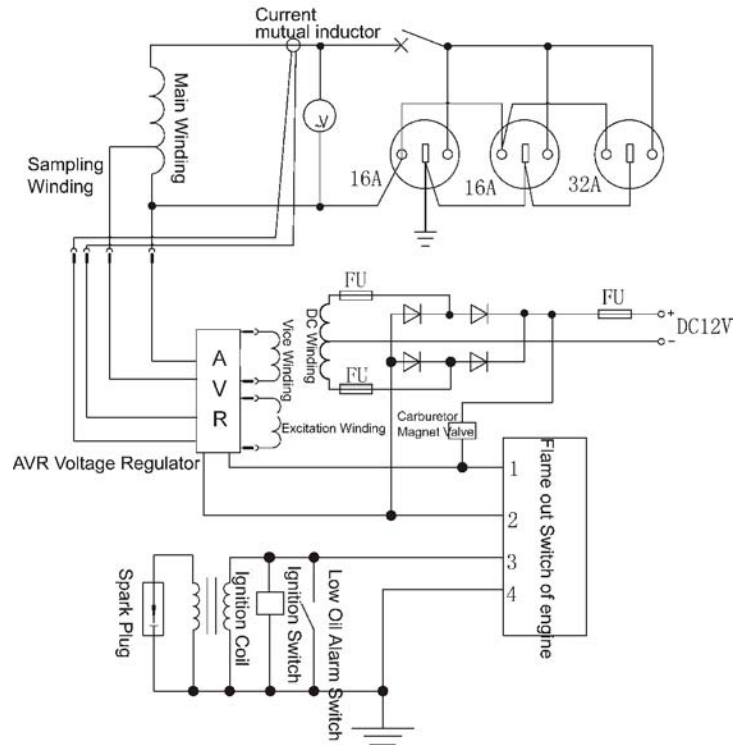

5-2 Application of AC

1. Starting the generating set

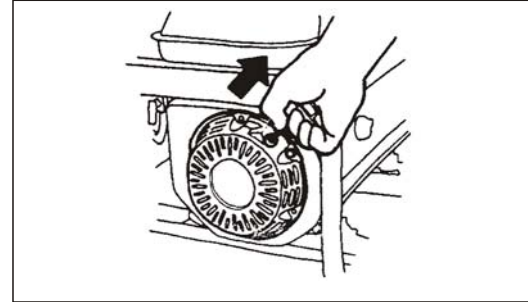



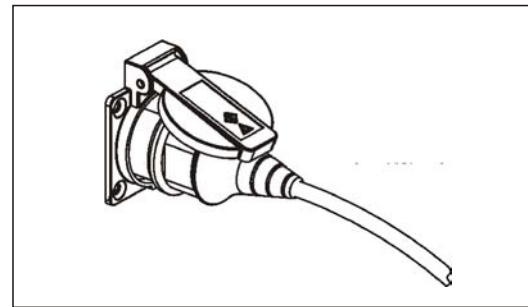



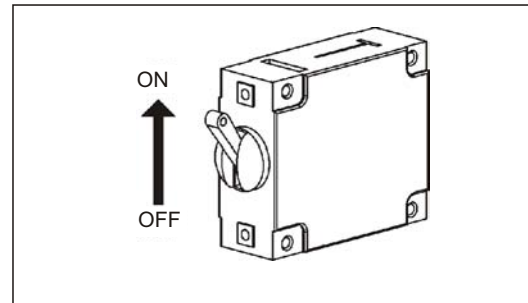

2. Connecting the load



3. Switch on the AC breaker



**5-3 Electrical apparatus particularly motor-driven equipment will produce very high current while starting, the below table provides the reference for connecting these apparatus to the set.**

TYPE	WATTAGE		TYPICAL APPLIANCE	EXAMPLE		
	STARTING	RATED		APPLIANCE	STARTING	RATED
<ul style="list-style-type: none"> <li>Incandescent lamp</li> <li>Heating appliance</li> </ul>	X1	X1	 Incandescent lamp  TV	 Incandescent lamp 100W	100VA (W)	100VA (W)
<ul style="list-style-type: none"> <li>Fluorescent lamp</li> </ul>	X2	X1.5	 Fluorescent lamp	 Fluorescent lamp 40W	80VA (W)	60VA (W)
<ul style="list-style-type: none"> <li>Motor-driven equipment</li> </ul>	X3~5	X2	 Refrigerator  Electric fan	 Refrigerator 150W	450-750VA (W)	300VA

Breaker can prevent the electric shock. If need to replace , please replace one that has equal degree and performance.

Electrical equipment (including electrical lines and plugs connection) could not be defective. By the effect of mechanical stress, make sure to use the rubber sheathed flexible cable or analog (accord with IEC245-4).

Limit length of electric line when using the extension line or distributed network is: less than 60m for cables of 1.5mm<sup>2</sup>, and less than 100m for cables of 2.5mm<sup>2</sup>

## 13. WIRING DIAGRAM

**13-1 Electric skeleton diagram of KGE2500X/E**

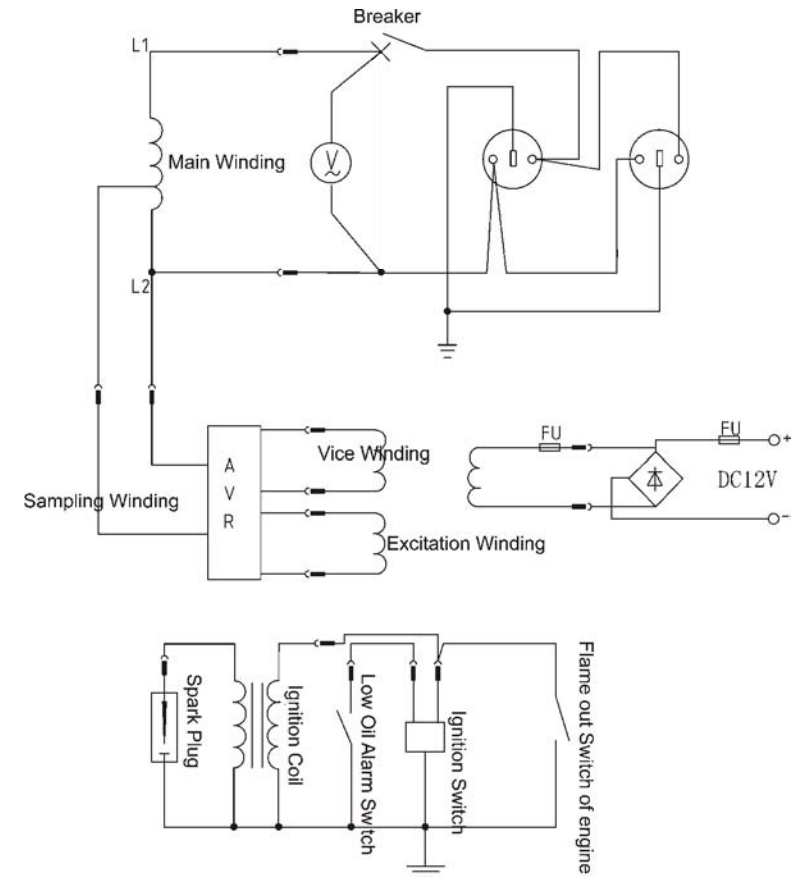

## 12. DESCRIPTION OF CASTOR UNIT (Optional Parts)

1. Fix the four castors on the axles with washer and pin.
2. Fix the axles on the generator with bolt and nut.

- |                         |                      |
|-------------------------|----------------------|
| (1) Blot M8X20          | (5) Axle welded      |
| (2) Flat washer 12      | (6) Flat washer 8    |
| (3) 4" PU-Wheel (Φ 100) | (7) Elastic washer 8 |
| (4) Split pins 3.2X40   | (8) Nut M8           |

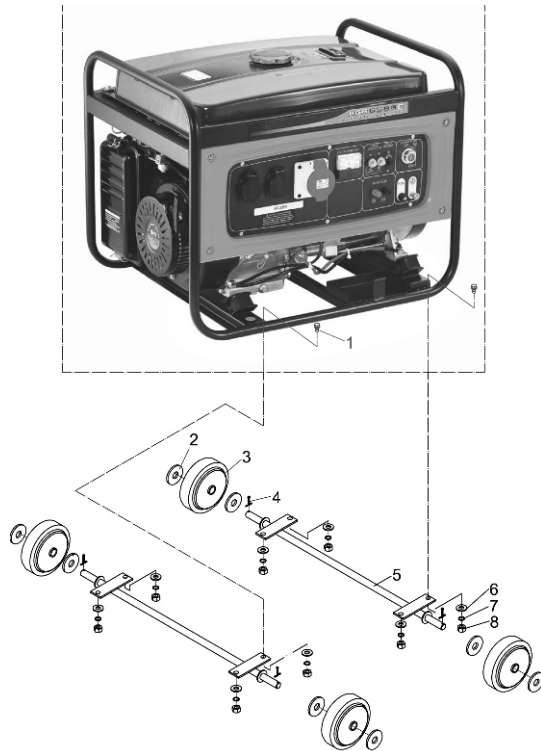

## 6. STOPPING THE GENERATING SET

### 6-1 Switch off the AC breaker

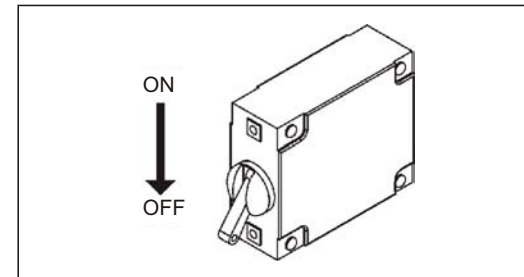

### 6-2 Switch off the engine switch

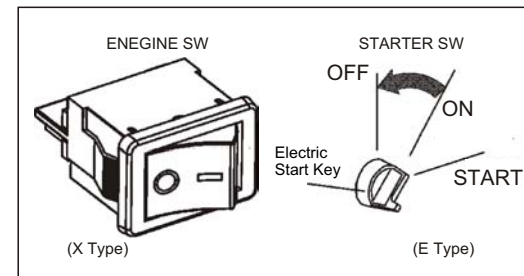

### 6-3 Close the fuel valve

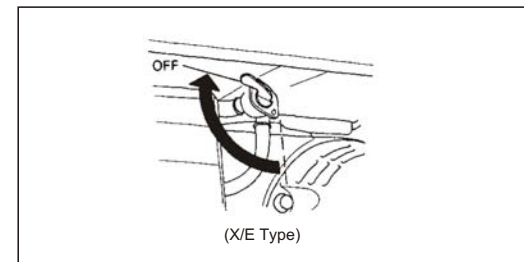

**Note:** If you want to stop the engine in emergency, please set the engine switch

## 7. MAINTENANCE

Periodical inspection and maintenance are very important for keeping your generating set in best working condition.

Be sure to shut down the set before performing maintenance, however, if it is necessary to run the set, good ventilation must be provided, for the exhaust contains poisonous carbon monoxide.

Item	Maintenance Time	Each use	The first month or first 20 Hrs.	Every 3 months or 50 Hrs.	Every 6 months or 100 Hrs.	Each year or 300 Hrs.
Engine oil	Check	○				
	Replace		○		○	
Air cleaner	Check	○			○	
	Clean			○		
Fuel strainer cup	Clean				○	
Spark plug	Clean Adjust				○	
Air valve clearance	Clean Adjust					○(2)
Cylinder head cover	Clean					○(2)
Fuel tank Oil pipes	Check Clean					

### Note:

- (1) Shorten maintenance intervals if the generating set operated in dirty area.
- (2) The above-mentioned items must be performed with the assistance of dealer.

## 11. DESCRIPTION OF ACCUMULATOR UNIT (Optional Parts)

1. Assemble the accumulator unit with bolt, nut, and washer.
2. Connect the electric starting cable to the starting electromagnet.
3. Connect the grounding cable to the engine stand.
4. First connect the electric starting cable to the positive pole the accumulator, then the negative pole, while disconnect the electric starting cable in reverse order.

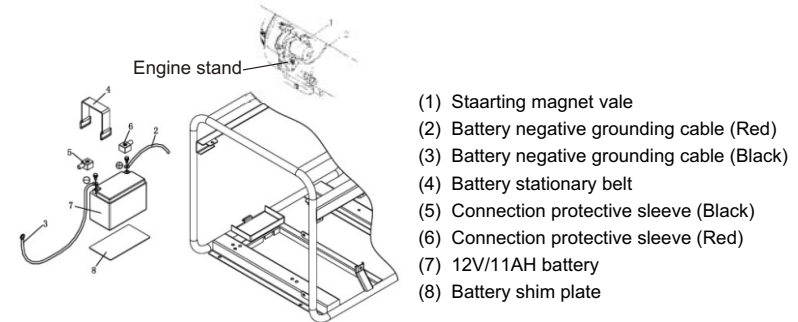

The battery of E type generator is optional parts, the user should select the suitable battery. The battery that our company supply use non-maintenance technology, so user don't need to add water or liquid during using.

The color that in the inside of the magic eye of battery can judge whether the battery should recharge or not:

Blue: the battery is in good condition

White: the electricity is not enough, need to charge.

Red: the electrolyte is not enough, need to change

### The battery usage attention:

Shut down the power after removing the battery cathode wire when checking and maintaining generator.

When connect the battery, first connect anode then connect cathode.

Stop charging quickly after the battery is charged full.

If the battery is overheating during charging, please stop for a while then recharging.

**Note 2:**

**Explanation of three-phase generating set:**

(1) Connect the loads to the generating set in order. As for the motor loads, start the higher power motor first, and then start the lower after the former started. Be sure not to start them simultaneously. Any improper operation arouse, the generating set will run sluggishly or halt, at this time, be sue to remove the loads immediately and shut off the motor. Check whether overload happened or any other faults. If overload made AC air breaker tripped, decrease the loads for overload is not allowed. Wait some minutes before restart the generating set, furthermore, do stop the set and make checks if any faults or abnormal phenomenon still existed.

(2) If both of motor loads and inductive loads (e.g. Incandescent) are connected to the generating set, first start motor loads and then inductive loads, otherwise, starting motor loads will be difficult.

(3) Pay more attention to voltage of three phases while running. If the imbalance of voltage of three phases exceeds 10%, do stop the set and make checks, and then readjust three phase loads. Keep three phase loads in balance, the imbalance cannot exceeds 20%. Meanwhile, the total load cannot exceeds rated load, even the load of each phase cannot exceeds rated phase load, that is 1/3 of rated load. Furthermore, the current of each phase cannot over rated current.

The sequence of output terminals A,B,C,O (or U,V,W,N) of three-phase generating set is from left to right or clockwise direction.

The bellow figure is the phase sequence of three-phase, five-hole-receptacle on the output panel:

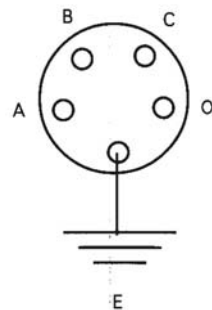

**7-1 Replace engine oil**

1. Open oil filler cap.

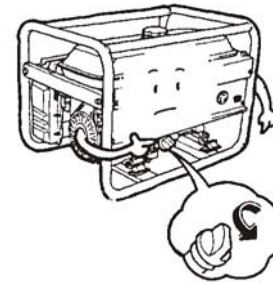

2. Loose drain screw plug to drain off engine oil.

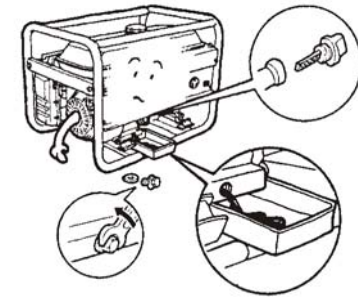

3. Reassemble the drain screw plug.

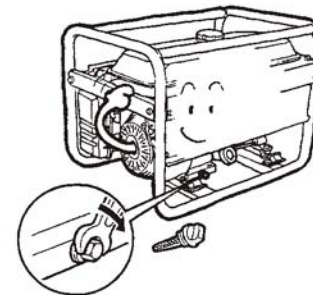

4. Refill engine oil until the upper limit level of the oil filler cap.

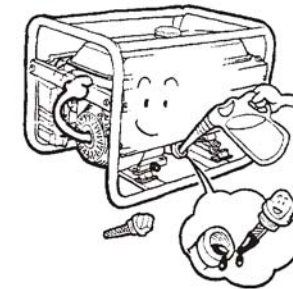

5. Reassemble the oil filler cap.

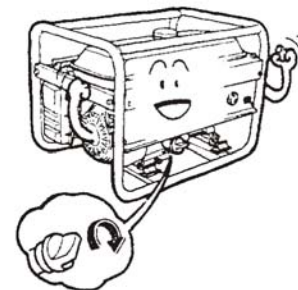

Recommend engine oil: Engine oil for 4-stroke gasoline engine SE, SF engine oil classified by API or SAE10W-30 engine oil which same as SG grade.

Use SAE10W-30 engine oil when the temperature is below 10°C.

Use SE, SF engine oil classified by API or SAE5W-30 engine oil which same as SG grade when the temperature is below -15°C.

7-2 Air cleaner (see 3-4)

7-3 Spark plug

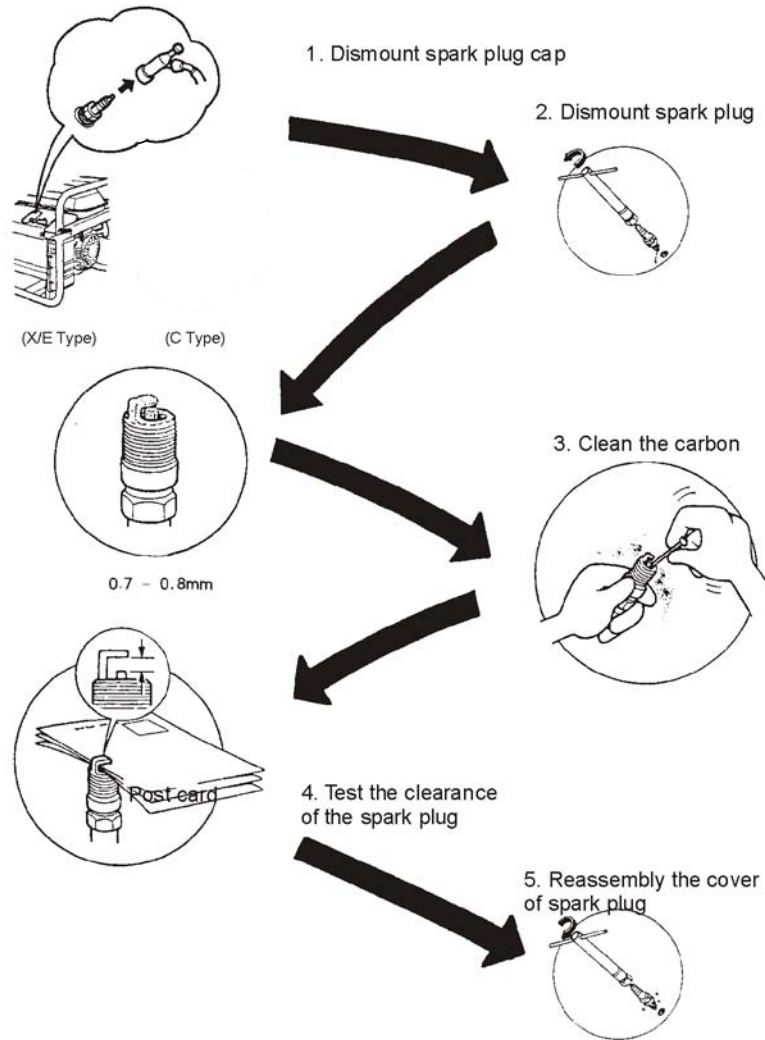

10-2 Technical specifications and data of three-phase generating set

Model		KGE6500X3, KGE6500E3		
Engine	Model	KG390		
	Type	4-stroke, OHV		
	Displacement (cm <sup>3</sup> )	389		
	Bore x stroke (cm)	88X64		
	Cooling system	Forced air-cooled		
	Ignition system	T.C.I		
	Spark plug	BP6ES		
	Fuel tank (L)	25		
	Engine oil capacity (L)	1.1		
	Compression ratio	8.5:1		
Generator	Rated frequency (Hz)	50	60	
	Rated voltage (V)	400/230	416/240	480/277
	Rated current (A)	8	8.6	7.5
	Rated output (kVA)	5.6	6.2	6.2
	Max output (kVA)	6	7	7
	Excitation method	Self-excitation and constant voltage (AVR)		
	Phase	Three-phase		
	Power factor cos $\phi$	0.8(lag)		
	Starting system	E3:12V electric starter; X3:manual starter		
	Net weight (kg)	E3:90	X3:83	
	Overall dimension (LxWx H)(mm)	E3:675X520X540	X3:675X520X540	

**Note 1:**

- E3 mode:Three-cylinder,luxury type electric starter,super tank,large muffler.
- Starting accumulator:12V 11AH.

**Noise Instruction:** the noise list indicates the noise emission level while not the safe working noise level. Although the noise emission level is related to the sound exposure level, it is not the judging standard for whether applying noise protection. Factors affect the practical noise level include: the ambient condition and other noise source, such as the quantity of working machine or the working hours in noisy condition. Furthermore, the sound exposure level varies among different countries.



## 10. MAIN TECHNICAL SPECIFICATIONS AND DATA

### 10-1 Technical specifications and data of single-phase generating set

		KGE2500X/E		KGE4000X		KGE6500X/E	
Engine	Model	KG200		KG280		KG390	
	Type	4-stroke, OHV					
	Displacement(cm <sup>3</sup> )	196		277		389	
	Bore x stroke (cm)	68×54		78×58		88×64	
	Cooling system	Air-cooled					
	Ignition system	T.C.I					
	Spark plug	F6TC					
	Fuel tank (L)	15		6		25	
	Lube oil (L)	0.8		1.1		1.1	
	Compression ratio	8.5:1					
Generator	Rated frequency (Hz)	50	60	50	60	50	60
	Rated voltage (V)	115/230	120/240	115/230	120/240	115/230	120/240
	Rated current (A)	17.4/8.7	18.3/9.2	26/13	29.2/14.6	43.5/21.7	45.8/22.9
	Rated output power (kVA)	2	2.2	3	3.5	5	5.5
	Max output power (kVA)	2.2	2.4	3.3	4	5.5	6.5
	Excitation method	Self-excitation					
	Phase	Single-phase					
	Power factor (cos φ)	1					
	DC output	12V/8.3A (C mode has no DC output)					
	Starting system	E: electric stater/manual stater; X: Recoil starter					
	Net weight (kg)	43		71		X:83 E:90	
	Overall dimension (L x W x H)(mm)	590×430×430		675×520×540		X: 680×510×540 E: 855×510×540	

X mode: Luxury type, manual starter, super tank, large muffler, lower noise.

E mode: Luxury type, electric starter, super tank, large muffler, lower noise.

### 7-4 Maintenance of the fuel filter

(1).Set the fuel valve on “OFF” position and dismantle the fuel strainer cup.

Dismount the fuel filter

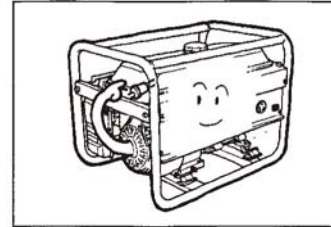

Blow it from the opposite direction of the arrow

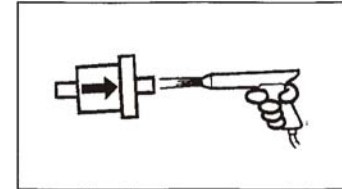

(2) Clean the strainer cup thoroughly.

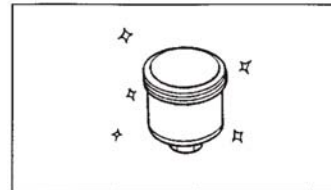

(3) Reassembly new rubber washer and strainer cup tightly.

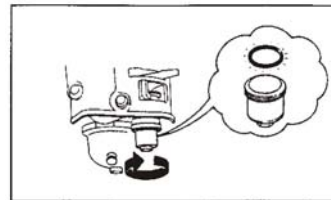

## 8. STORAGE

1. Remove the drain screw plug and drain out gasoline from the carburetor.

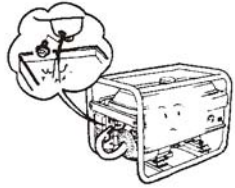

2. Remove the filler cap and drain screw plug, then drain off the engine oil.

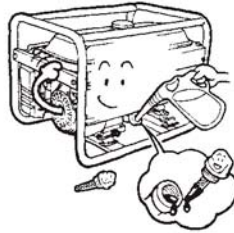

3. Reassembly the drain screw plug.

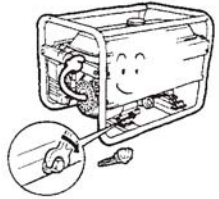

4. Untill the high limit of the filler cap.

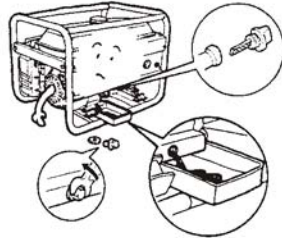

5. Pull out the starting handle slowly untill you feel resistance.

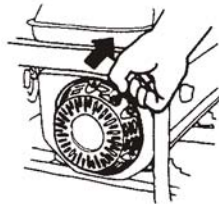

## 9. TROUBLESHOOTING

1. The generating set cannot start.

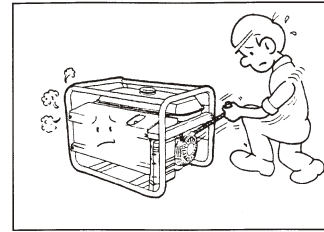

2. Whether the engine switch is in "OFF" position?

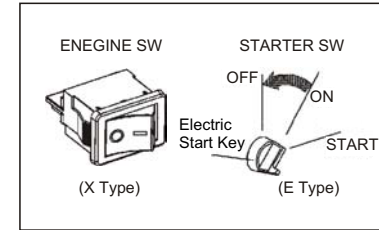

3. Check engine oil level.

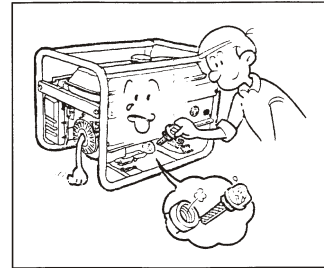

4. Check fuel oil level.

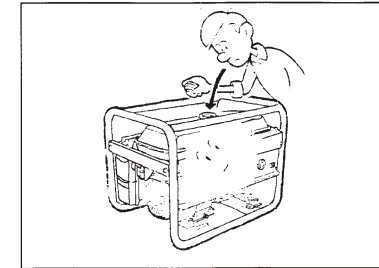

5. Dismount the spark plug.

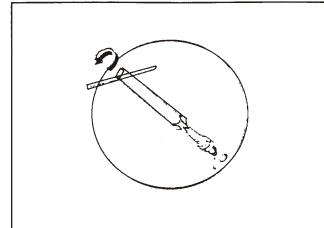

6. Check the spark plug.

